

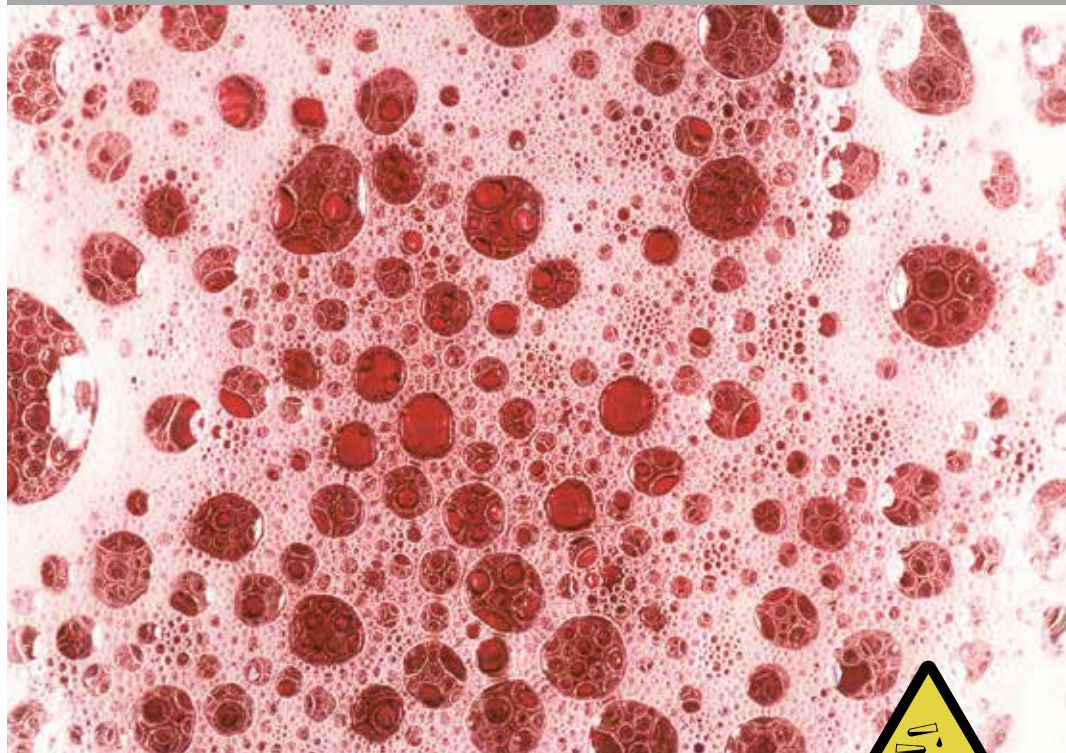

SEALLESS

# DRUM PUMPS PVDF

FOR HIGH AGGRESSIVE LIQUIDS  
THE RIGHT DRUM PUMPS



- This saves maintenance costs
- This avoids malfunctions
- This saves time
- This saves money

**If you have such applications,  
take only the best.**



**... and environment.**

**PVDF drum pumps take no ...**



**fright at any application ...**



## Advantages for the reliability

### This saves maintenance costs

- robust coupling
- strong shaft
- stainless steel for stressed parts
- new development without seal



## Advantages for the operational safety

### This avoids malfunctions

- optional magnetic clutch for hermetical sealed pump
- strong connection motor-pump



## Advantages for the user

### This saves time

- quick release coupling
- no problems with failed threads



## Advantages for the customer

### This saves money

- one supplier for the most applications
- one motor for all types of impeller
- less equipment required

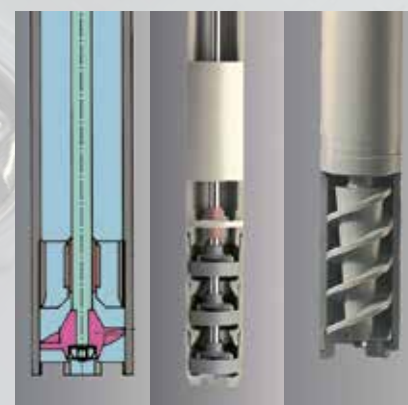

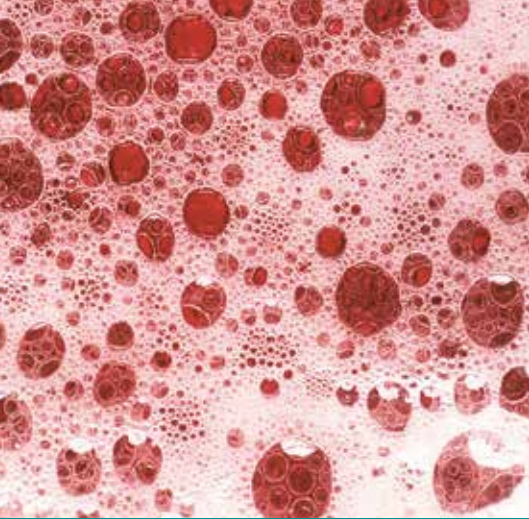

# DRUM PUMPS PVDF

FOR HIGH AGGRESSIVE LIQUIDS  
THE RIGHT DRUM PUMPS

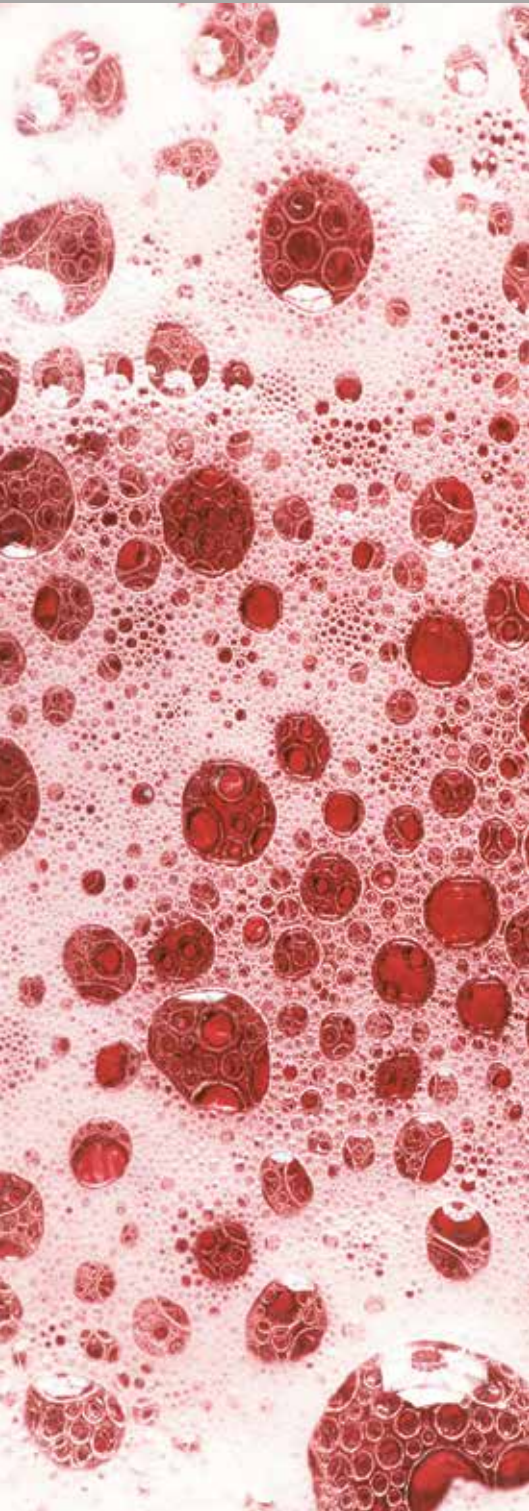

## SEALLESS



- **acid, concentrated**
- **bases, concentrated**
- mineral oil
- colours
- emulsions
- dispersions
- suspensions
- fluids of medium viscosity
- cosmetics



**For high aggressive liquids...**

Version A, R column 1-2, page 7



**For high aggressive and li-  
quids of medium viscosity...**

Version S column 3, page 7

**SL-PVDF:**

For transfilling and draining of drums and containers.

The perfect drum pump for the most thin liquids. Version A for high flow rate, Version R for high pressure, with foot valve for complete drainage.

**Recommendation:**

For heavy liquids the strong motor p400-A.

**SL-PVDF-S:**

The feed screw (S) is dedicated for liquids of medium viscosity ( $\eta > 200$  mPas), if the impeller types A and R reach their limitations.

With induction motor ideal combination for gentle dealing with the liquid.

**Recommendation:**

Induction motor with frequency inverter, for variable flow rate.

## Sealless pumping units

Sealless pump tubes from grün are reliable without using a mechanical seal and are suitable for almost any aggressive, low viscosity media. Our sealless pumping units are available in PP, PVDF, stainless steel (SS) and aluminium (Alu) material versions.

(Separate brochure for each material available).



- **optimised in price**
- **short and occasional usage**
- **it likes light and thin liquids**
- **opt. LVR: low voltage release for advanced safety**
- **opt. SR: speed reducer for simple flow rate variation**

### Design PVDF:

The pump tube (3) is divided by the inner tube into sections to separate the fluid under pressure (3 flow channels) and the low pressure section (wave channel).



- **the ideal drive**
- **big resources in power and durability**
- **quick working and saving time**
- **opt. LVR: low voltage release for advanced safety**
- **opt. SR: speed reducer for simple flow rate variation**
- **opt. IP 54: 230V Order-No. 500-0052**

### Advantages of sealless drum pumps

► Cleaning the pumping unit is greatly facilitated; the risk of fluid carry-over when moving the pump to a different container is minimized.

► The build-in webs add considerable rigidity to the pump tube, resulting in greatly improved mechanical stability of the pumping unit.

► No bearings in the wave channel.

► Motor power is transferred by proven, robust coupling (1) with curved teeth over the stainless steel coupling element (2) with a large double bearing.

► Of course, the sealless pump tubes are fully compatible with the sealed models, allowing you to use the pumping units with any motor from grün product range.

► Depending on the application you can select one of 3 different types of impellers: axial (A), radial (R) and feed screw (S).



- **the power drive**
- **variable speed**
- **starting knob fixable**
- **for heavy duty**
- **easy handling**
- **economical air consumption**

### Product profile

A drum pump always consists of a pump tube and a motor. These components are connected by means of a quick coupling. Any pump tube can be used with any motor.

#### Selecting the right order-no.

In the general order-no., for example 500-00XX, fill in the specific numbers for your choice.  
Example: p400-A 230V: Order-No. 500-0024



- **the silent marathon worker**
- **ideal for viscous liquids**
- **smooth product treatment with feed screw**
- **voltage 230 V (1-ph) and 400 V (3-ph)**
- **opt.: with frequency inverter**
- **opt.: Ex-proof versions**

Motor		Pump tube	1	2	3
p310		Performance curve	SL-PVDF-A	SL-PVDF-R	SL-PVDF-S
Power (W)	520	Hydr. Values	A100	R100	
Voltage (V)	230 / 120	Capacity Q (l/min)	max	max	
Protection	IP 24	Delivery head H (mWS)	6	14	
LVR*	optional	Density ϕ (kg/l)	1,3	1,6	
		Viscosity η (mPas)	300	250	
Weight (kg)	3,5	Weight (kg)	1,8	1,8	
		Temperature (°C)	80	80	
Order-No.	500-00XX	L (mm)	Order-No.	Order-No.	
Voltage (V)	230 120				
p310 (LVR)	16 28	700	680-0001	685-0001	
p310-A	17 29	1000	680-0002	685-0002	
p310-A-SR	54 -	1200	680-0003	685-0003	

Motor		Pump tube	1	2	3
p400		Performance curve	SL-PVDF-A	SL-PVDF-R	SL-PVDF-S
Power (W)	850	Hydr. Values	A200	R200	S200
Voltage (V)	230 / 120	Capacity Q (l/min)	max	max	max
Protection	IP 24	Delivery head H (mWS)	8	20	10
LVR*	optional	Density ϕ (kg/l)	1,6	2,0	1,5
		Viscosity η (mPas)	800	700	700
Weight (kg)	4	Weight (kg)	1,8	1,8	2
		Temperature (°C)	80	80	80
Order-No.	500-00XX	L (mm)	Order-No.	Order-No.	Order-No.
Voltage (V)	230 120				
p400 (LVR)	23 25	700	680-0001	685-0001	680-0006
p400-A	24 26	1000	680-0002	685-0002	680-0007
p400-A-SR	56 -	1200	680-0003	685-0003	680-0008

Motor		Pump tube	1	2	3
d600		Performance curve	SL-PVDF-A	SL-PVDF-R	SL-PVDF-S
Power (W)	600	Hydr. Values	A600	R600	S600
Pressure (bar)	3-7	Capacity Q (l/min)	max	max	max
Consumption of air (l/s)	10	Delivery head H (mWS)	7	15	8
Weight (kg)	1,7	Density ϕ (kg/l)	1,6	2	1,5
		Viscosity η (mPas)	800	700	700
Order-No.		Weight (kg)	Order-No.	Order-No.	Order-No.
		Temperature (°C)			
		L (mm)			
d600	520-0016	700	680-0001	685-0001	680-0006
		1000	680-0002	685-0002	680-0007
		1200	680-0003	685-0003	680-0008

Motor		Pump tube	1	2	3
pd500		Performance curve	SL-PVDF-A	SL-PVDF-R	SL-PVDF-S
Power (W)	see below	Hydr. Values			S500
Voltage (V)	230 / 400	Capacity Q (l/min)			max
Protection	IP 54	Delivery head H (mWS)			7
Overload release	1 ph: yes	Density ϕ (kg/l)			1,9
	3 ph opt.	Viscosity η (mPas)			1500 (min 100)
Weight (kg)	5	Weight (kg)			2
		Temperature (°C)			80
Order-No.		L (mm)			Order-No.
d500-1 370W	500-0042	700			680-0006
		1000			680-0007
d500-3 370W	500-0039	1200			680-0008

\* LVR: Low voltage release (restart protection)

Other voltages on demand.

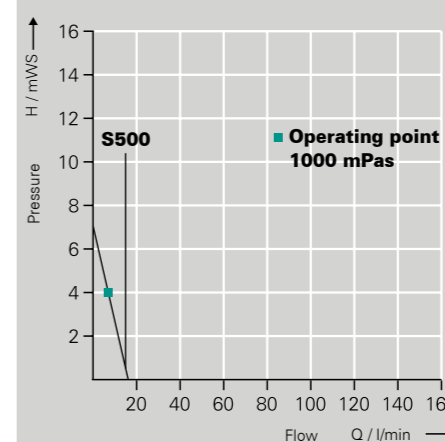
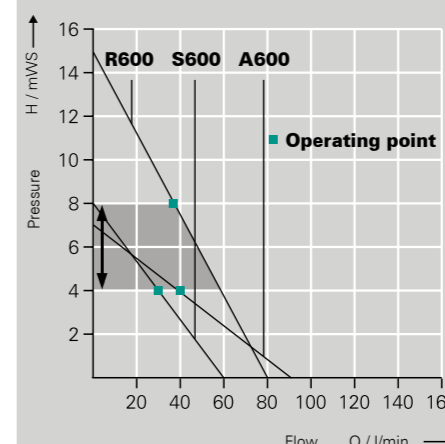
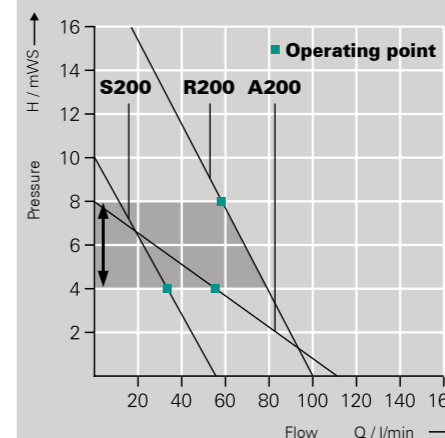
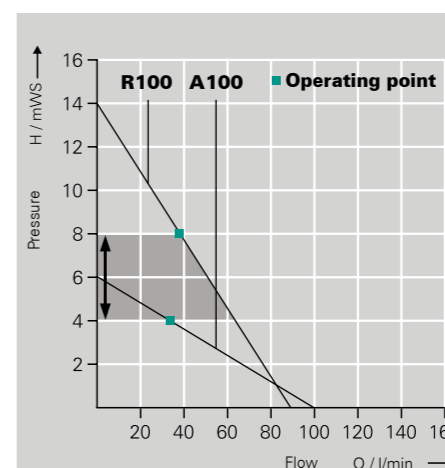

## Table of materials

Description	Pump tube version
<b>PVDF</b>	
1. Curved teeth coupling	PA
2. Coupling element	PVDF/SS
3. Pump tube with	
flow and wave channel	PVDF
4. Drive shaft	HC
5. Wave channel	PVDF
6. Slide bearing	PTFE
7. Impeller	ETFE

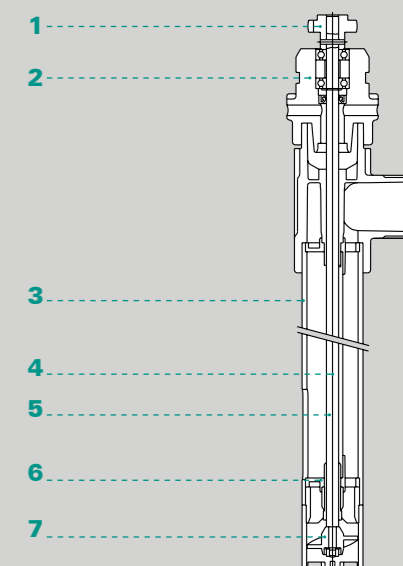

Cross-section of pump:

When fluid enters the wave channel, a surge hole allows it to escape into the fluid area surrounding the pumping unit. In the wave channel is no overpressure and the fluid level in both (wave channel and drum) is always the same. For this reason the pump doesn't need a seal between drive shaft and housing.

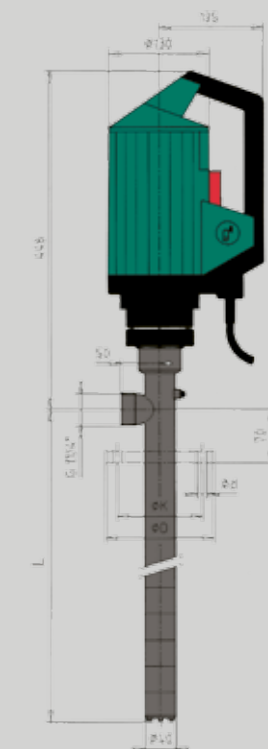

**Mechanical sealed (MS) pumps  
in separate catalogue.**



# ACCESSORIES

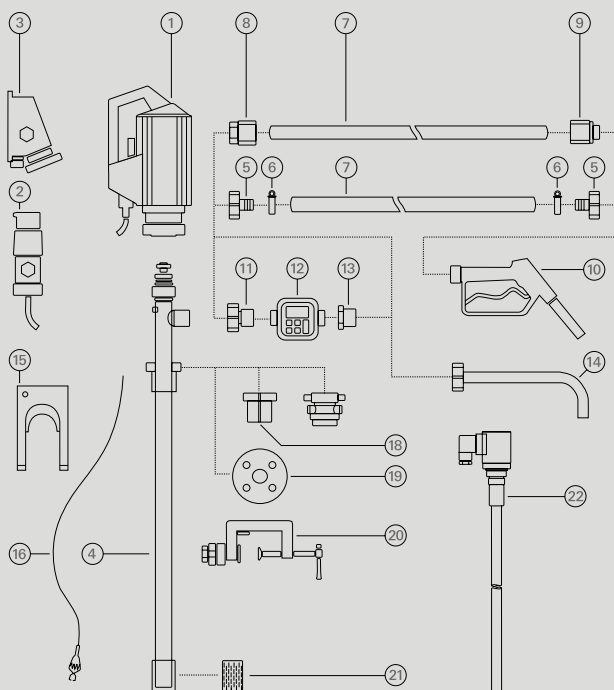

- 1 Drive motor
- 2 Explosion-proof plug
- 3 Explosion-proof socket
- 4 Pump tube
- 5 Hose connector
- 6 Hose clamps
- 7 Hose
- 8 Hose fittings
- 9 Hose fittings
- 10 Nozzle
- 11 Flow meter connection
- 12 Flow meter
- 13 Reducing piece
- 14 Discharge spout
- 15 Wall bracket
- 16 Equipotential bonding cable
- 17 Emission proof drum adapter
- 18 Drum adapter
- 19 Installation flange
- 20 Clamping device
- 21 Foot strainer
- 22 Level switch

**Distributor:**

**grün-pumpen gmbh**  
**Otto-Schott Str. 19**  
**D-97877 Wertheim**  
**Telefon +49 93 42 9 35 16-0**  
**Telefax +49 93 42 9 35 16-29**  
**info@gruen-pumpen.de**  
**www.gruen-pumpen.de**

**Handelsregister:**  
**Reg. Gericht Mannheim**  
**HRB 570326**  
**Sitz der Gesellschaft:**  
**Wertheim**  
**Geschäftsführer:**  
**Ralph Dostmann, Dr. Thomas Sigel**  
**USt.IdNr. DE 160765854**

**g**<sup>®</sup>  
**grün-pumpen**  
 take out, what's in.